

# H-PCF

## Fiber-Optic Cords/Cables

H-PCF

### Features of Hard Plastic Clad Silica Fiber (H-PCF)

#### Advantages of H-PCF over conventional optical communication fibers

- ① High NA feature (capability to capture a large amount of light) ensures compatibility with low-cost optical modules (electrical-to-optical and optical-to-electrical transducers).
- ② Another feature of H-PCF is its suitability for use with easy-to-fit crimp & cleave optical connectors. As an optical fiber for medium- to long-distance transmission involving the use of many optical modules and connectors, H-PCF is effective in reducing system installation costs and extending transmission distances.

Approximate optical module pricing

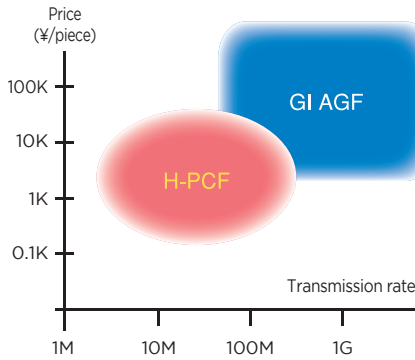

Assembling crimp & cleave optical connector (optical connector CF-2071)

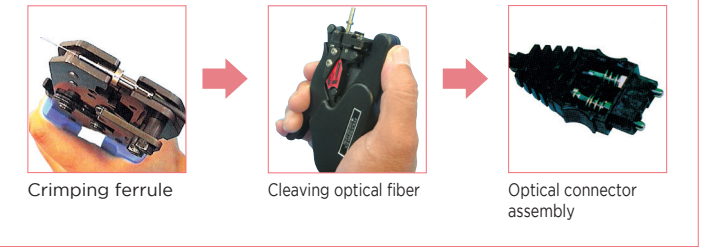

#### H-PCF structure

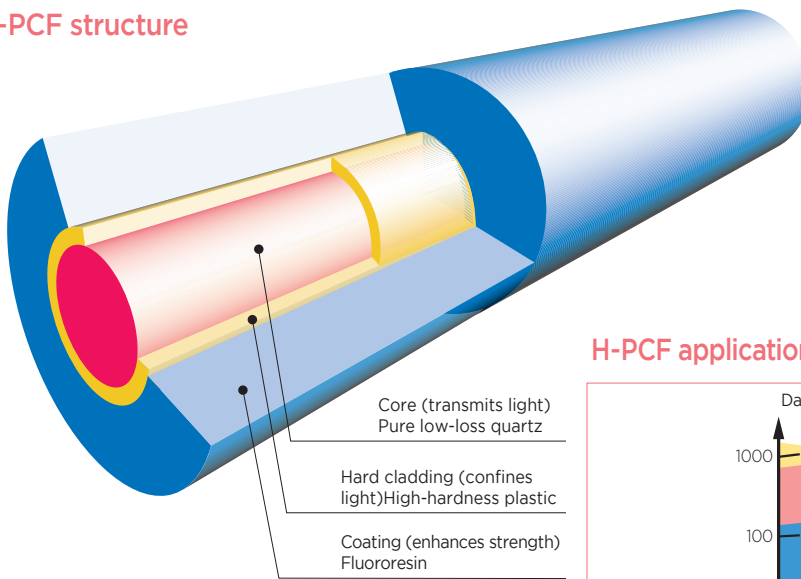

#### H-PCF applications, data rates, and transmission distances

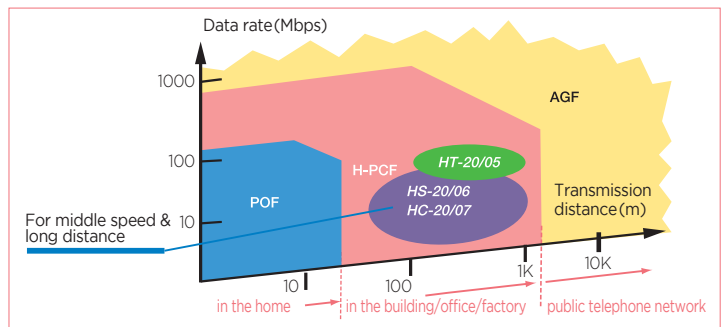

#### Excellent wavelength characteristics

##### Transmission loss versus wavelength

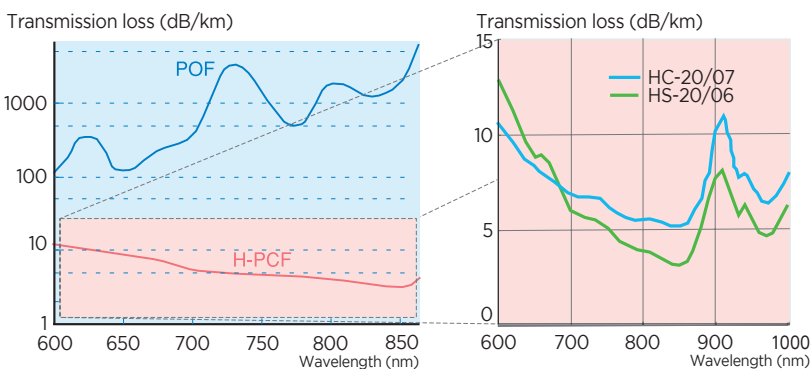

#### Excellent mechanical characteristics

##### Bending loss characteristics

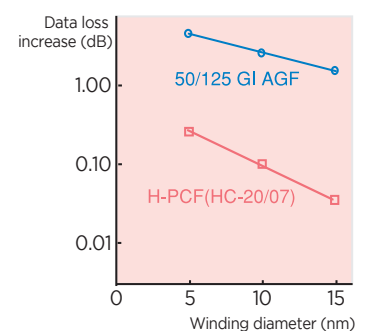

## Fiber-Optic Cords/Cables

### Standard Type (HC)

#### H-PCF Fiber Types

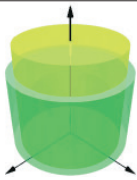
Product name	HC-20/07
Category	Standard SI
Fiber type	HC
Refraction-index profile	
Core material	Silica glass
Core diameter [μm]	200
Cladding material	Fluoroacrylate
Cladding diameter [μm]	230
NA	0.4*2
Attenuation [dB/km]	7
Bandwidth [MHz/km]	14*2
Test wavelength [nm]	800 band
Application	General industries and FA

\*1. The figure depends on the light source. Contact us for further information.  
 \*2. The figures are for reference purposes.

#### H-PCF Cords

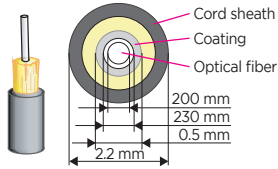
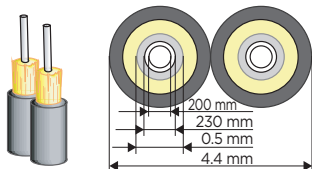
Cord type	Single-fiber cord
Schematic drawing	
Outer diameter	2.2 mm
Cord type	2-fiber cord
Schematic drawing	
Outer diameter	2.2×4.4 mm

#### H-PCF Cables (2-fiber cables are shown as examples.)

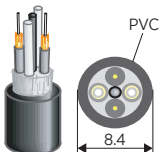
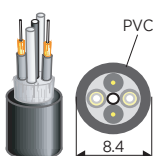
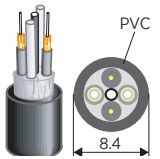
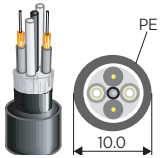
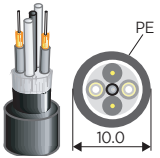
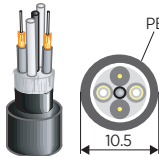
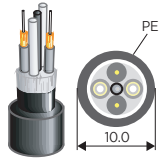
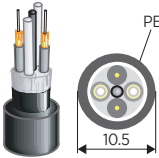
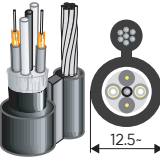
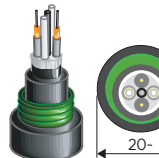
Type/Application	Standard Cord	Flexible	Nonmetallic	
Indoor*2	Product name:2-C-V 	Product name:2-C-VCT 	Product name:NM2-C-V 	
Outdoor	Product name:2-C-LAP 	—	—	
Feature	—	Highly flexible	No metal included	
Type/Application	Flame-retardant	Fire-resistant	Overhead	Underground
Indoor*2	Product name:SF2-C-LAP 	Product name:SF-400-OPT*3 	—	—
Outdoor	Product name:SF2-C-LAP 	Product name:SF-400-OPT*3 	Product name:2-C-LAP-SSD 	Product name:2-C-LAP-MAZE 
Feature	Resists the spread of fire.	Resistance to fire*3	With messenger wire	With metal armor

\*1. In cases where the cable length needs to be 200 m or more, or if a great tension will be applied to the cable during laying, such as when pulling the cable with a winch, use a multi-type optical fiber cable with a center tension member.  
 \*2. A LAP-sheathed outdoor cable must be used even for indoor use if a cable is anticipated to be soaked or immersed in water.  
 \*3. Fiber-optic cables of this class meet the criteria for heat-resistant fiber-optic cables (Circular Notice No. 178 dated December 12, 1986, by the Director, Fire and Ambulance Service Division, Fire and Disaster Management Agency, Ministry of Home Affairs). They resist heating in a pattern following the fire temperature curve, reaching 380°C in 15 minutes, and are suitable for control and operation purposes in fire protection systems.  
 \* For eco-friendly types and composite feeder line types, consult us.

# H-PCF

## Fiber-Optic Cords/Cables

H-PCF

### Compound-Glass-Fiber-Compatible Type (HS)

#### H-PCF Fiber Types

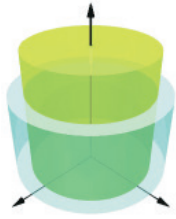
Product name	HS-20/06
Category	Standard SI
Fiber type	HS
Refraction-index profile	
Core material	Silica glass
Core diameter [μm]	200
Cladding material	Fluoroacrylate
Cladding diameter [μm]	250
NA	0.46*
Attenuation [dB/km]	6
Bandwidth [MHz/km]	10*
Test wavelength [nm]	800 band
Application	General industries and FA

\* The figures are for reference purposes.

- As pure silica glass with no impurities is used as a core for the compound-glass-fiber-compatible fiber, attenuation is less than half that with the compound-glass fiber, enabling data transmission with improved system margin and higher reliability.
- The use of pure silica glass instead of inherently weak compound glass and reinforcement with hard polymer cladding results in mechanically strong, reliable fiber cords and cables.
- Highly accurate connector attachment is possible without a cumbersome and skill-requiring polishing process (only cleaving with the special cutter is required).

#### H-PCF Cords

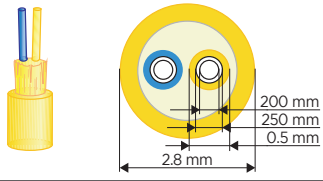
Cord type	2-fiber round cord
Schematic drawing	
Outer diameter	2.8 mm

#### H-PCF Cables (2-fiber cables are shown as examples.)

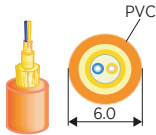
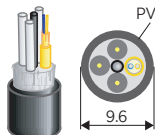
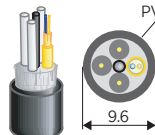
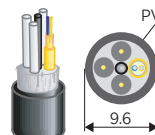
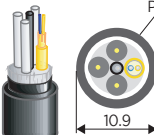
Type/Application	Standard	Reinforced type	Flexible	Nonmetallic
Inside a control board	Cord	—	—	—
	Product name:2-FOD-V*1	Product name:2-D-V	Product name:2-D-VCT	Product name:NM2-D-V
Indoor*2				
Outdoor	Product name:2-D-LAP		—	—
				
Feature	—	Center tension member	Highly flexible	No metal included

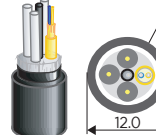
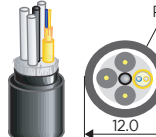
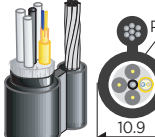
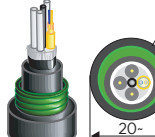
Type/Application	Flame-retardant	Overhead	Underground
Inside a control board	—	—	—
	Product name:SF2-D-LAP	—	—
Indoor*2		—	—
Outdoor	Product name:SF2-D-LAP	Product name:2-D-LAP-SSD	Product name:2-D-LAP-MAZE
			
Feature	Resists the spread of fire.	With messenger wire	With metal armor

\*1. In cases where the cable length needs to be 200 m or more, or if a great tension will be applied to the cable during laying, such as when pulling the cable with a winch, use a multi-type optical fiber cable with a center tension member.  
 \*2. A LAP-sheathed outdoor cable must be used even for indoor use if a cable is anticipated to be soaked or immersed in water.  
 \*3. Fiber-optic cables of this class meet the criteria for heat-resistant fiber-optic cables (Circular Notice No. 178 dated December 12, 1986, by the Director, Fire and Ambulance Service Division, Fire and Disaster Management Agency, Ministry of Home Affairs). They resist heating that follows the fire temperature curve, reaching 380°C in 15 minutes, and are suitable for control and operation purposes in fire protection systems.  
 \* For ecological types and composite feeder line types, consult us.

## Installation location

### Installation location and Application Category

○.....Suitable x.....Not to be used

Type	Inside panel	Rack	Trough	Conduit	Outdoor conduit	Overhead	Buried
Single-fiber cord	○	×	×	○*1,*2	×	×	×
2-fiber cord	○	×	×	○*1,*2	×	×	×
Indoor cable (2-C-V etc.)	○	○*1,*2	○*1,*2	○*1,*2	×	×	×
Outdoor cable (2-C-LAP etc.)	○	○	○	○	○	×*3	×
Self-support cable (2-C-LAP-SSD etc.)	—	—	—	—	—	○	×
Steel-armored cable (2-C-LAP-MAZE etc.)	—	—	—	—	—	—	○

\* Excessive tensions and side pressures must be avoided.

\* The weatherability of colored sheaths is low. Always choose black cables for installation in places exposed to direct sunlight.

\*1. A LAP-sheathed outdoor cable must be used even for indoor use if a cable is anticipated to be soaked or immersed in water.

\*2. Since cable sheaths are made of PVC, it is recommended to use LAP-sheathed cables (with the outermost layer being made of polyethylene) where an oil or chemical harmful to PVC is used. Flame-resistant cables must be used for installation in a culvert (in accordance with Article 143 of the Electric Installation Engineering Standards).

\*3. The cables are suitable if appropriate hangers are used.

### Installation location Requirements

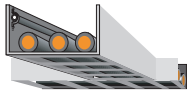
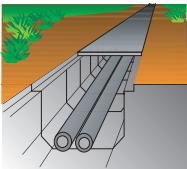
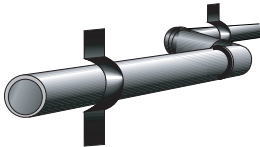
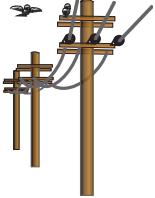
	Rack	Trough	Conduit	Outdoor conduit	Overhead
Installation location					
Cord	Provide protection against damage caused by falling objects.	—	—	—	—
Cable	Provide protection against excessive forces if present.	Provide protection against excessive forces if present.	Conduits are assumed to be made of steel or PVC.	Avoid any sections immersed in water.	Excessive tension or vibration must not be applied.

# H-PCF

## Optical Connectors/Tools

H-PCF

### For Standard (HC) Cords/Cables

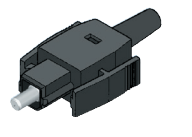
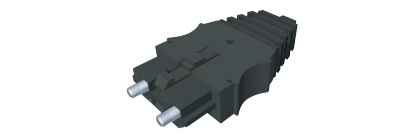



Applicable standard	JIS F01(FC)	JIS F05		JIS F07	
Optical connector-equipped cable	The optical connectors shown below can be factory-attached to various standard cords or cables at your request.				
	—	Glue & polish type		Crimp & polish type	
	—	Product name:CF-1001H	Product name:CF-1501H	Product name:CF-2071H	Product name:CF-2071TE
					
	Another option for the user is to purchase the desired items from the various standard cables and optical connectors shown below and to assemble them using the tools shown below.*1				
Optical connectors (field assembled) and fitting tools	Crimp & and cleave type				
	Product name:CAF-230C-P	Product name:CF-1071	Product name:CF-1571	Product name:CF-2071	
					
	Use the tools below to assemble the crimp & cleave connectors shown above.				
	Product name:CAK-0057-EX 				
Reference fiber	Consult us.	Product name:CAT-1001H*2		Product name:CAT-2001H*2	
Inline adapter	—	—		Product name:IAT-4000*3	
	—	—			

\*1. Users are recommended to attend our technical workshop provided for the correct use of these products. For more information, visit: [http://www.optigate.jp/course/hpcf\\_course.html](http://www.optigate.jp/course/hpcf_course.html)

\*2. For other types of H-PCF fiber than the HC-20/07, contact us.

\*3. Due to the insertion of an inline adaptor, the transmission distance is shortened.

### For Cords/Cables of Compound-Glass-Fiber-Compatible Type (HS)

Applicable standard	Optical connector	Tool	Power tester	Reference fiber	Inline adapter
JIS F08	Product name:DL-72	Product name:CAK-0068-EX	Product name:CAT-7200*1	Product name:CAT-7201H	Product name:IAT-7000*2
				—	

\*1. Two power tester sets are required for the measurement of cables after laying.

\*2. Due to the insertion of an inline adaptor, the transmission distance is shortened.

## Fiber-Optic Transmission Modules SUMILINK™ for Short Optical Link Applications

### High-Reliability Type (metal can/ceramic package)



### Dimensional Drawings for High-Reliability Type

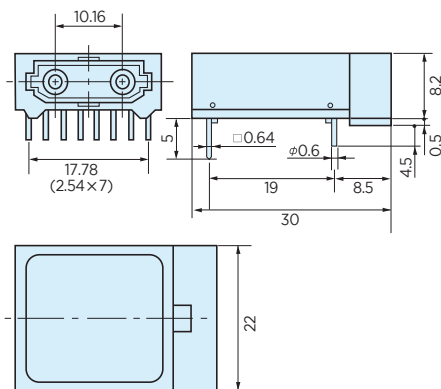

Product name	Transmitting module Receiving module	DF-2310
Peak emission wavelength		870 nm
Data rate (NRZ)*1		DC-4Mbps
Applicable fiber		200/230(HC-20/07)
Applicable optical connector*2	JIS	F07
	Glued	CF-2001H,CF-2071H
	Crimped	CF-2071
Dynamic range*3		11 dB
Maximum transmission distance*4		1000 m
Storage temperature		-40~+85 °C
Operating temperature		-20~+75 °C
Package		Metal can
Note		TTL interface, +5 V single power supply

- \*1. The figures are typical values, which are subject to change depending on the duty ratio of the transmitted signal and other operating conditions.
- \*2. Factory-assembled glued connectors and easily field-assembled crimped connectors are available as compatible optical connectors. Regarding mating, these connectors are either lever-locked or friction-locked. To assemble a crimped optical connector, the CAK-0057-EX is required. For detailed information, ask our sales staff for technical data sheets and specifications.
- \*3. The figures are typical design values, which are subject to change depending on the data rate, storage and operating temperatures, and other conditions.
- \*4. For detailed information, ask our sales staff for technical data sheets and specifications.

### Description and Features of each package

Package	Metal can	
Structure	Transmitting end 	Receiving end 
Reliability	◎	
Feature	<ul style="list-style-type: none"> <li>● Hermetically sealed construction for excellent resistance to moisture</li> <li>● Protection of chip surfaces from external stresses</li> <li>● More costly than molded plastic packages</li> </ul>	<ul style="list-style-type: none"> <li>● Hermetically sealed construction for excellent resistance to moisture</li> <li>● High noise-immunity due to DF-2310 body encased in a metal case</li> <li>● Protection of chip surfaces from external stresses</li> <li>● More costly than molded plastic packages</li> </ul>

### Notes on the selection and use of optical links

- Although Sumitomo Electric is striving to improve the quality and reliability of its products (“Product”), semiconductor products commonly malfunction or fail. It is the customer’s responsibility to implement necessary, safe designs of hardware, software, and overall systems that incorporate the Product so that any malfunction or failure of the Product will not result in endangering life, injury, or damage to property.
- The Product is intended for use in general electronic equipment (computers, personal electronic equipment, office equipment, measuring equipment, industrial robots, home appliances, etc.).
- The Product is neither intended nor warranted for use in equipment that requires exceptionally high levels of quality and reliability, or the failure or malfunction of which may threaten life, cause injury, or damage property, or have a serious impact on society (“Specific Use”).
- Specific Use includes, and is not limited to, nuclear-related equipment, aerospace equipment, medical equipment, equipment in automobiles, trains, ships and other transportation, traffic signal equipment, combustion/explosion-related equipment, safety devices, elevators, escalators, electric power equipment, and financial equipment. Application of the Product for Specific Use must be avoided.
- Sumitomo Electric will review and decide whether or not your use falls under Specific Use. In the case that we determine your use falls under Specific Use, we will not sell you the Product, as a general rule.